

5813

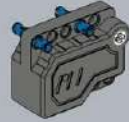

1



2



3

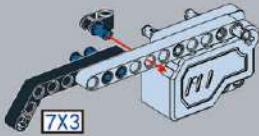

4

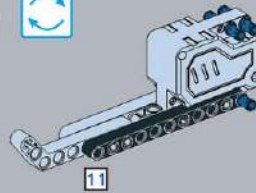

5

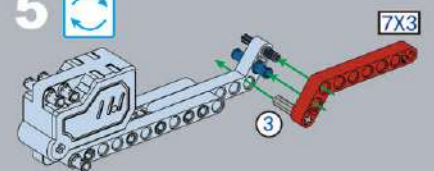

6

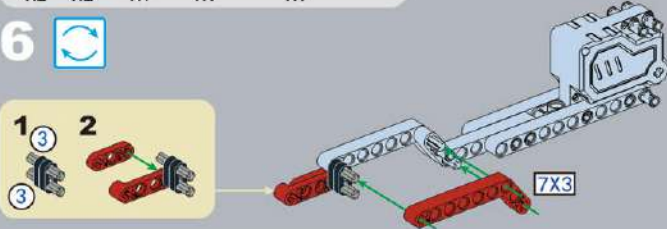

7

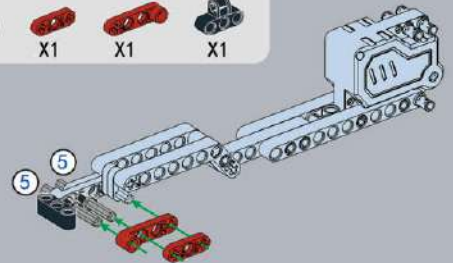

8

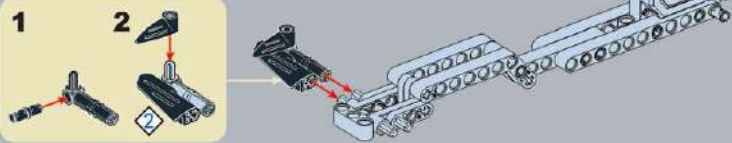

9

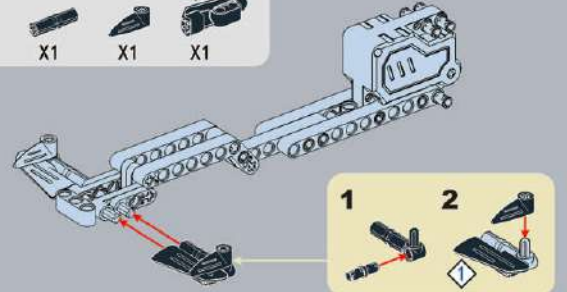

10

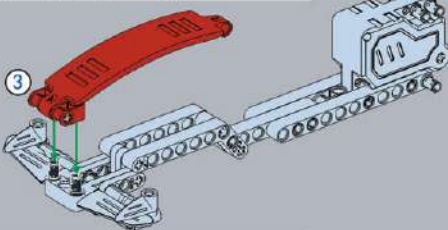
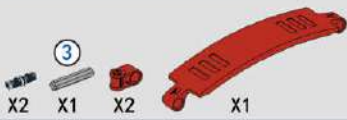

11

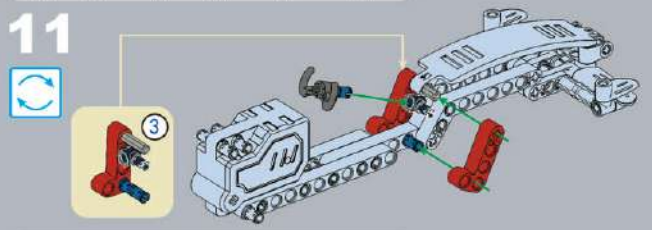

12

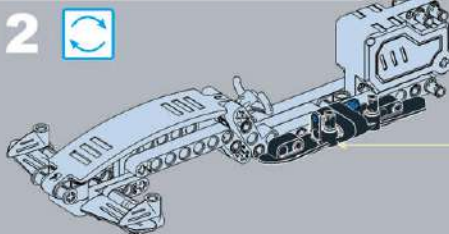

13

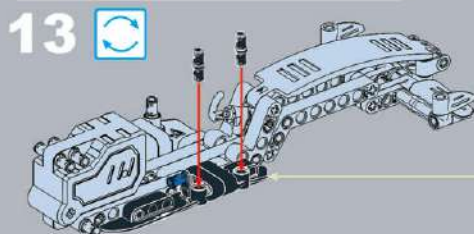

1



2



- ② X2 X2 X1 X2 X2 X1 X1

14

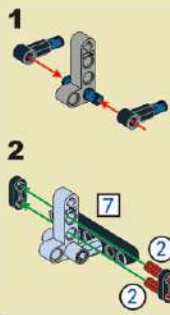
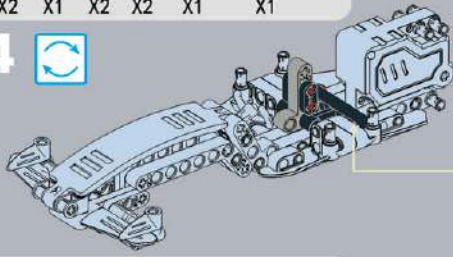

15

- X1 X1

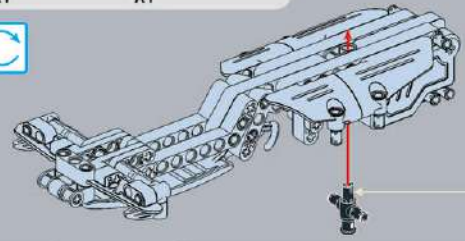

- X1 X1 X1

16

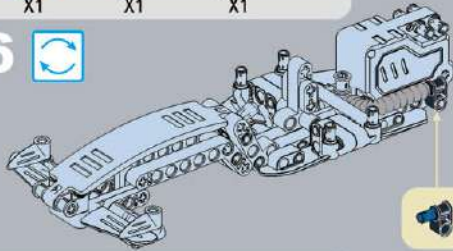

- X1 X1 X1

17

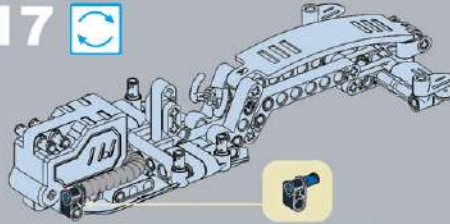

- X1 X2 X1 X1

18



- X4 X1 X1

19

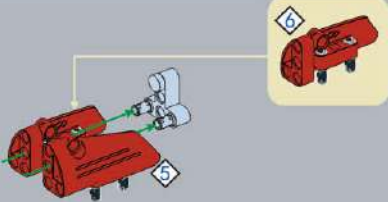

- ③ X2 X2 X2 X2

20

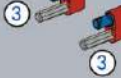
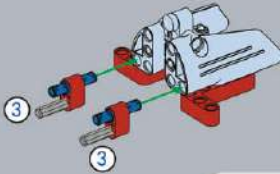

- ① X1 X1 X1 X1

21

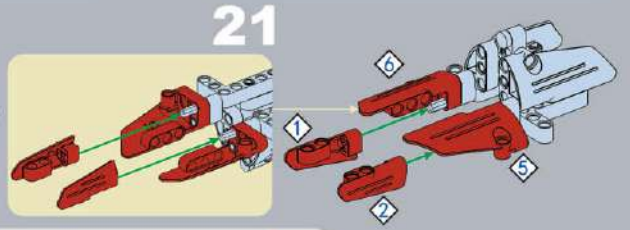

- X1 X1 X1 X1 X1 X2 X1

23

22

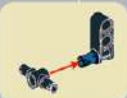
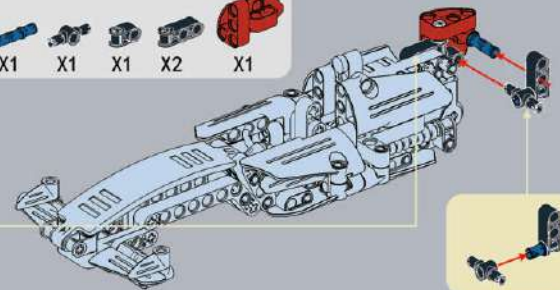
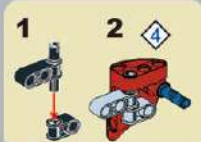
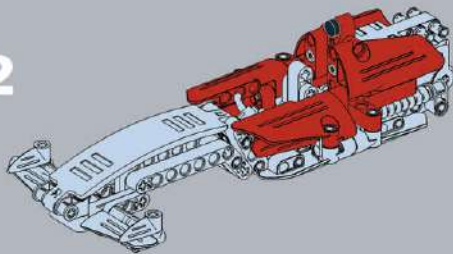

- X1 X1 X1 X1

24

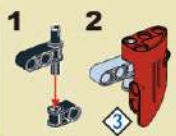
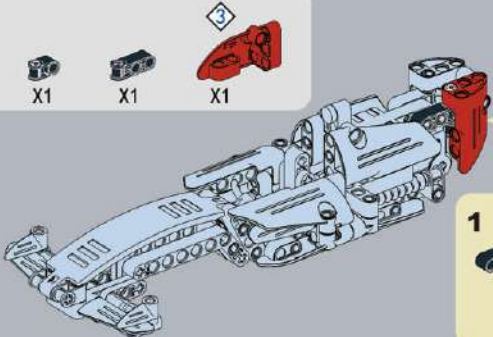

- ⑫ X2 X4 X12 X4

25

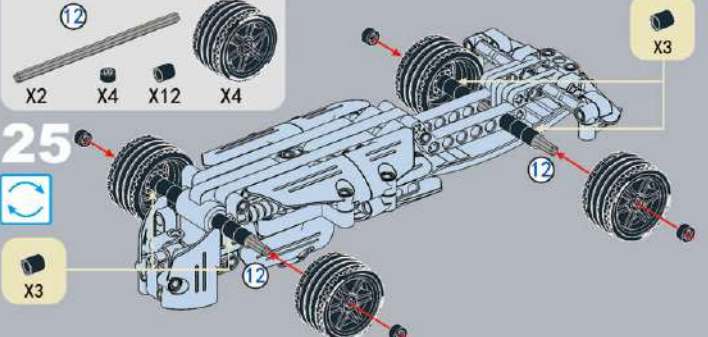

- X3

26

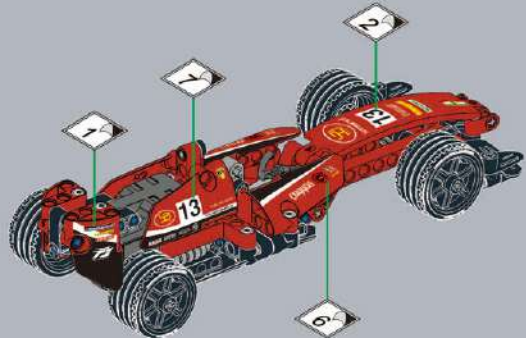

27

